

20W SLIMLINE FLOODLIGHTS



SAVE LIGHT

IP65 LED FLOODLIGHTS STANDARD & PIR VERSIONS – 20W



Features & Benefits

- Slimline Design
- IP65
- Available in Standard and PIR Version
- PIR version has a Manual override function
- Available in 10W, 20W, 30W, 50W & 80W
- Available in 3000K & 6500K
- 3 year warranty



Standard



PIR

Specification

Power	20W	
Lumens	3000K	1300lm
	6500K	1400lm
LED Type	COB	
Input Voltage	AC100-240V	
Beam Angle	120°	
Life Expectancy	30,000hrs	
Switching Cycles	>40000	
Start Time	<1s	
Approvals	CE, RoHS	
Warranty	3 years	

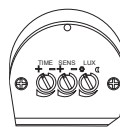
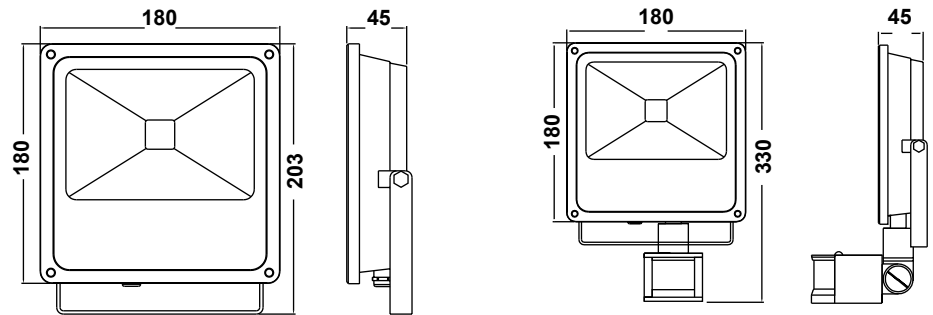
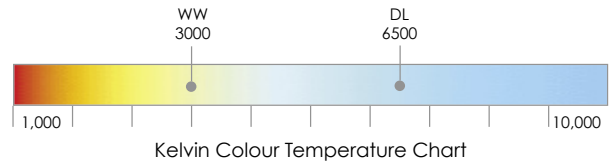

Settings Available:
Time
Sensitivity
Lux Levels (Ambient Light)

Detection Range: 180°, 12M Max @ 2.5M Height

Parameter	Min.	Max.
Lux Levels	5 LUX	2000 LUX
Time	8s	7 Minutes

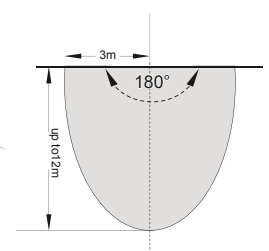
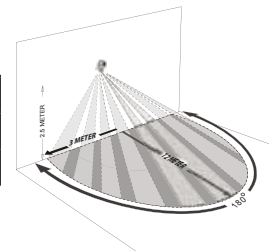

Product Code	PIR	Power Output	Lumens	Colour Temp	Beam Angle	Input Voltage	Dimensions H x W x D
FL-20W-WW	–	20W	1300lm	3000K	120°	AC100-240V	203 x 108 x 45
FL-20W-WW-PIR	Yes	20W	1300lm	3000K	120°	AC100-240V	330 x 180 x 45
FL-20W-CW	–	20W	1400lm	6500K	120°	AC100-240V	203 x 108 x 45
FL-20W-CW-PIR	Yes	20W	1400lm	6500K	120°	AC100-240V	330 x 180 x 45